



THE ULTIMATE IN A 36 DEGREE ROTATION, SINGLE DECK ROTARY SWITCH, A SUBMINIATURE PRECISION ROTARY SELECTOR SWITCH, THE SERIES 1150 IS 0.320 INCHES IN DIAMETER AND RATED AT 25,000 OPERATIONAL CYCLES. IT HAS BEEN ENGINEERED TO MEET ALL APPLICABLE REQUIREMENTS OF MIL-DTL-3786.



The Innovative Switch Company

The basic series 1150 is available as a 1 pole, 2-10 position or a 2 pole, 2-5 position switch. It is a non-shorting switch with 36 degree indexing. It has PC terminals and shaft seals for contaminant free operation.

The Series 1150 is well suited for avionics, communications, test equipment and command and control applications where space is at a premium and tough environmental reliability requirements are necessary.

Quality construction, including materials that meet the strictest standards, allows these subminiature switches to combine superior current switching capabilities with constant low contact resistance. Exceedingly stringent manufacturing processes, inspection and testing requirements ensure long life and high reliability.

The A1150 and B1150 are designed for the addition of a panel seal. These switches are perfect for miniature switch applications where contamination control is a must and harsh environments are expected. They are ideal when long life and precision in extreme conditions are necessary.

1150 SERIES

Subminiature Enclosed Precision Rotary Switch

The A1150 uses the same body as the standard 1150 but with a smaller shaft and ferrule to allow a panel seal. The B1150 uses the standard 1150 shaft and ferrule sizes with a larger body diameter to allow a panel seal.

1150 SERIES

Subminiature Enclosed Precision Rotary Switch

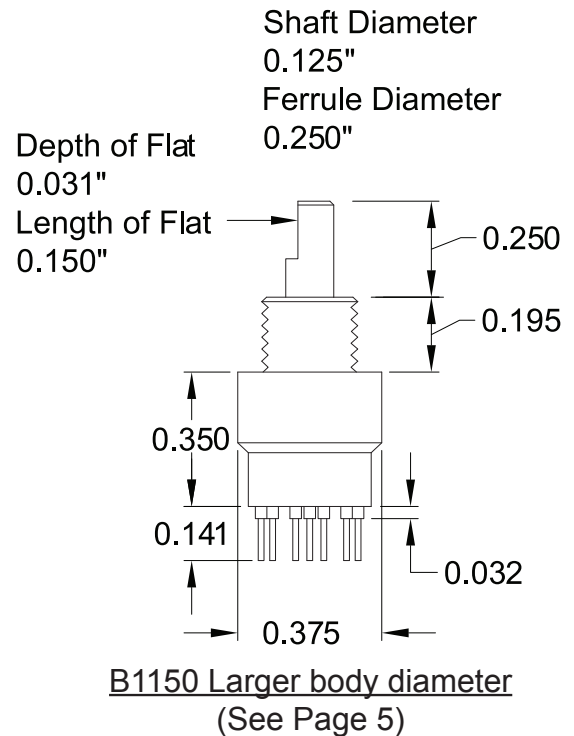
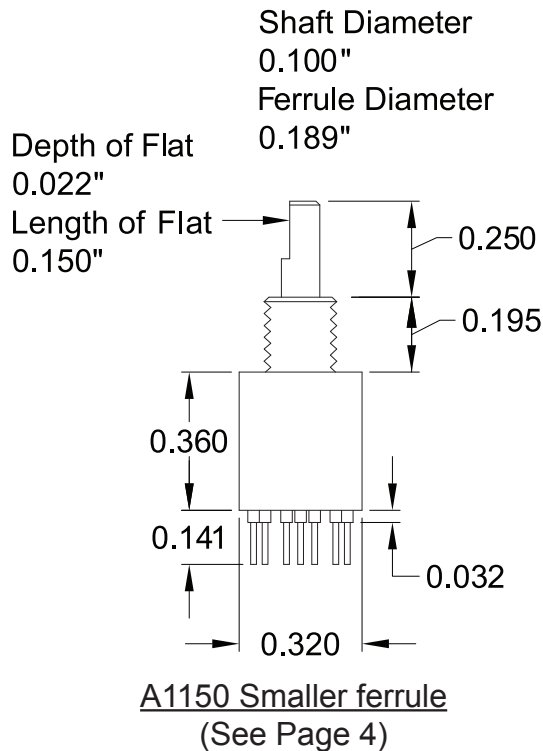
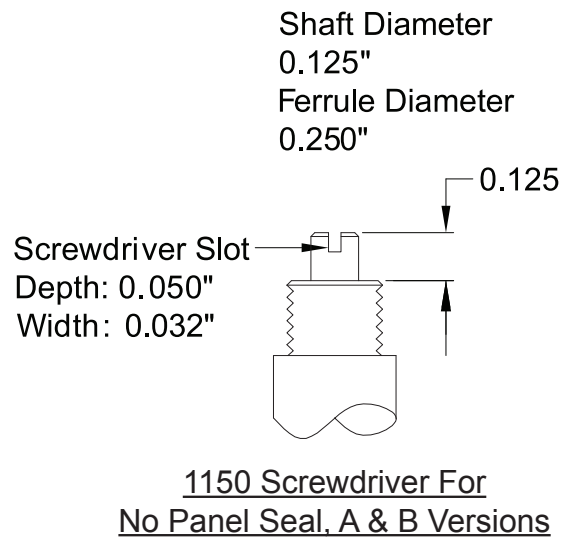
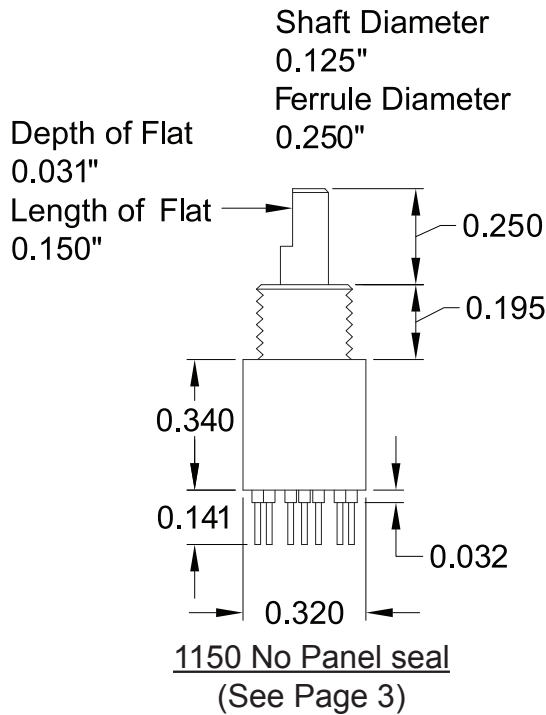

NOTES:

1150 - .125 Shaft Dia., .250 Ferrule Dia., .320 Body Dia., No Panel Seal, (See Page 3)

A1150 - .100 Shaft Dia., 10-32 Ferrule Dia. (.189 Ferrule Dia.), .320 Body Dia., Panel Seal, (See Page 4).

B1150 - .125 Shaft Dia., .250 Ferrule Dia., .375 Body Dia., Panel Seal, (See Page 5).

1150 SERIES

Subminiature Enclosed Precision Rotary Switch

1150 - NO PANEL SEAL

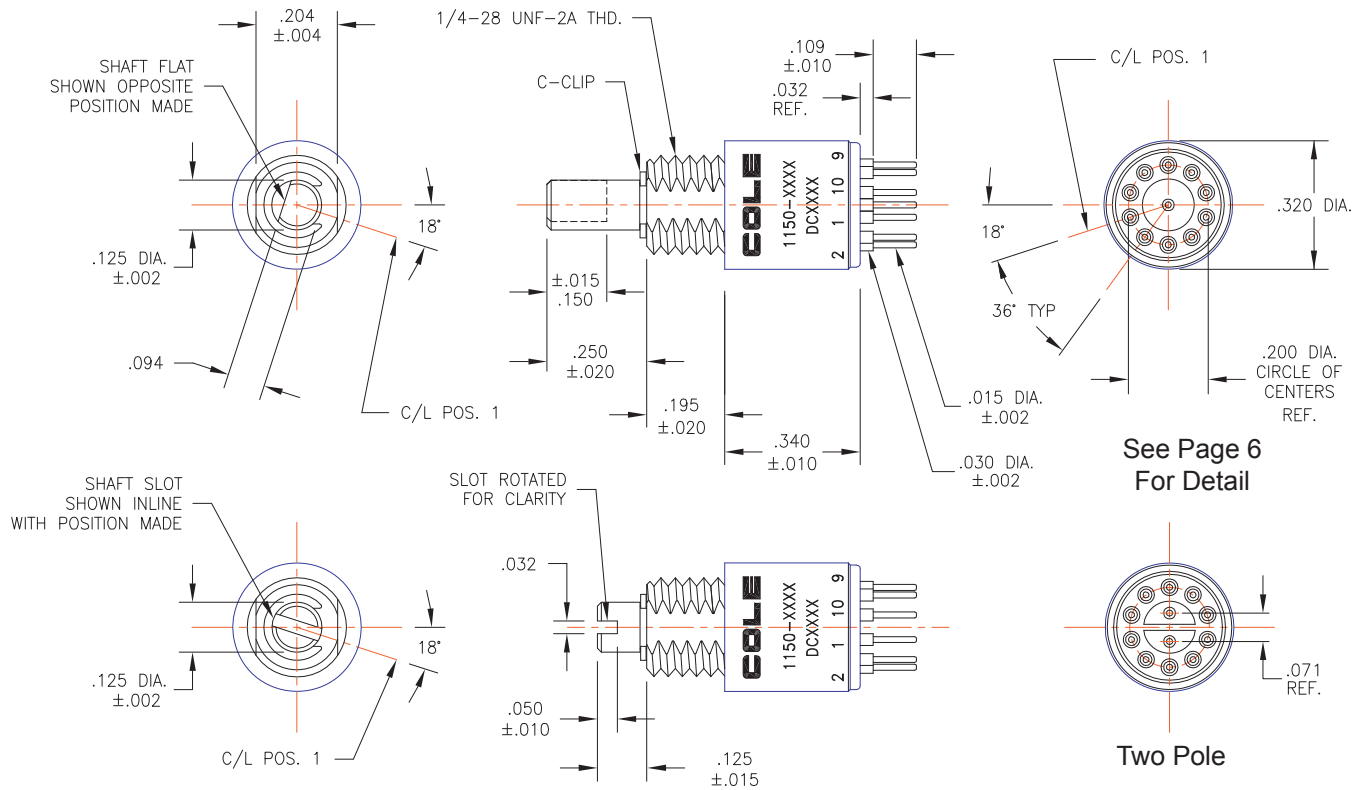

See Page 6
For Detail

Two Pole

Notes:

1. Dimensions are in inches.
2. Unless otherwise specified, tolerances are $\pm .005$ and $\pm 3^\circ$ on angles (non-accumulative).
4. The screw-driver slotted shaft dimensions are indicated; all other remains the same.
The slot in the shaft lines up with the point of contact of pole number one.
5. Switch is available with non-shorting contact only.
6. See page 6 for circuit diagram and all typical features.

ORDERING INFORMATION

Sample code

11 36- 1 04 ****

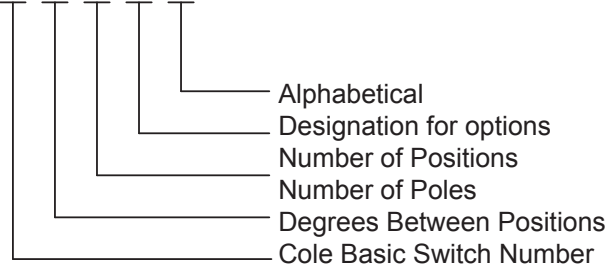

OPTIONS

The following options can be added to the standard switch. When ordering, simply add the letter after the basic part number.

F = Fixed stop between the first and last position on the 10 position switch

P = Seal (shaft only)

SD = Screwdriver Slot

S = Shorting (not available)



2650 South Croddy Way Phone: 714.556.3100
 P.O. Box 25063 Fax: 714.241.9061
 Santa Ana, CA 92799-5063 Email: sales@cole-switches.com

www.cole-switches.com

ISO9001 CERTIFIED

©2020 Cole Instrument Corp. All rights reserved. C-010318

1150 SERIES

Subminiature Enclosed Precision Rotary Switch

A1150 - SMALLER FERRULE

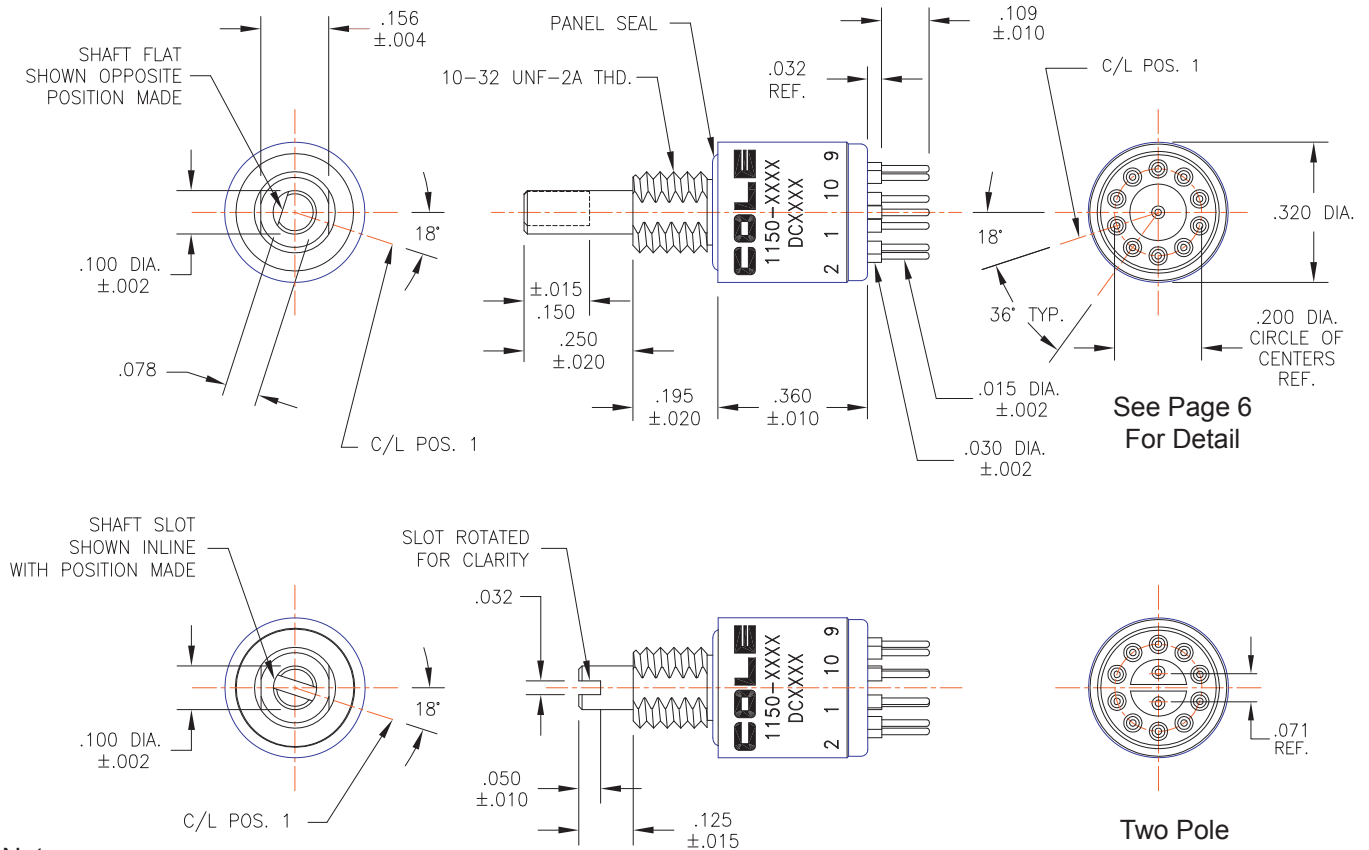

Notes:

1. Dimensions are in inches.
2. Unless otherwise specified, tolerances are ± 0.005 and $\pm 3^\circ$ on angles (non-accumulative).
4. The screw-driver slotted shaft dimensions are indicated; all other remains the same.
The slot in the shaft lines up with the point of contact of pole number one.
5. Switch is available with non-shortng contact only.
6. See page 6 for circuit diagram and all typical features.

ORDERING INFORMATION

Sample code

A1136-104****

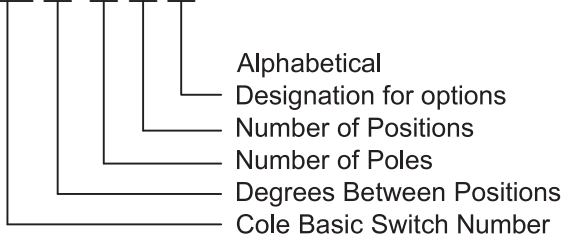

The 1150 series without options if furnished with PC termination, non-shortng and without shaft and panel seals. The standard 10 positions switch is continuous rotation.

OPTIONS

The following options can be added to the standard switch. When ordering, simply add the letter after the basic part number.

F = Fixed stop between the first and last position on the 10 position switch

P = Seal (shaft and panel)

SD = Screwdriver Slot

S = Shortng (not available)



2650 South Croddy Way Phone: 714.556.3100
 P.O. Box 25063 Fax: 714.241.9061
 Santa Ana, CA 92799-5063 Email: sales@cole-switches.com

www.cole-switches.com

ISO9001 CERTIFIED

©2020 Cole Instrument Corp. All rights reserved. C-010318

1150 SERIES

Subminiature Enclosed Precision Rotary Switch

B1150 - LARGER BODY DIAMETER

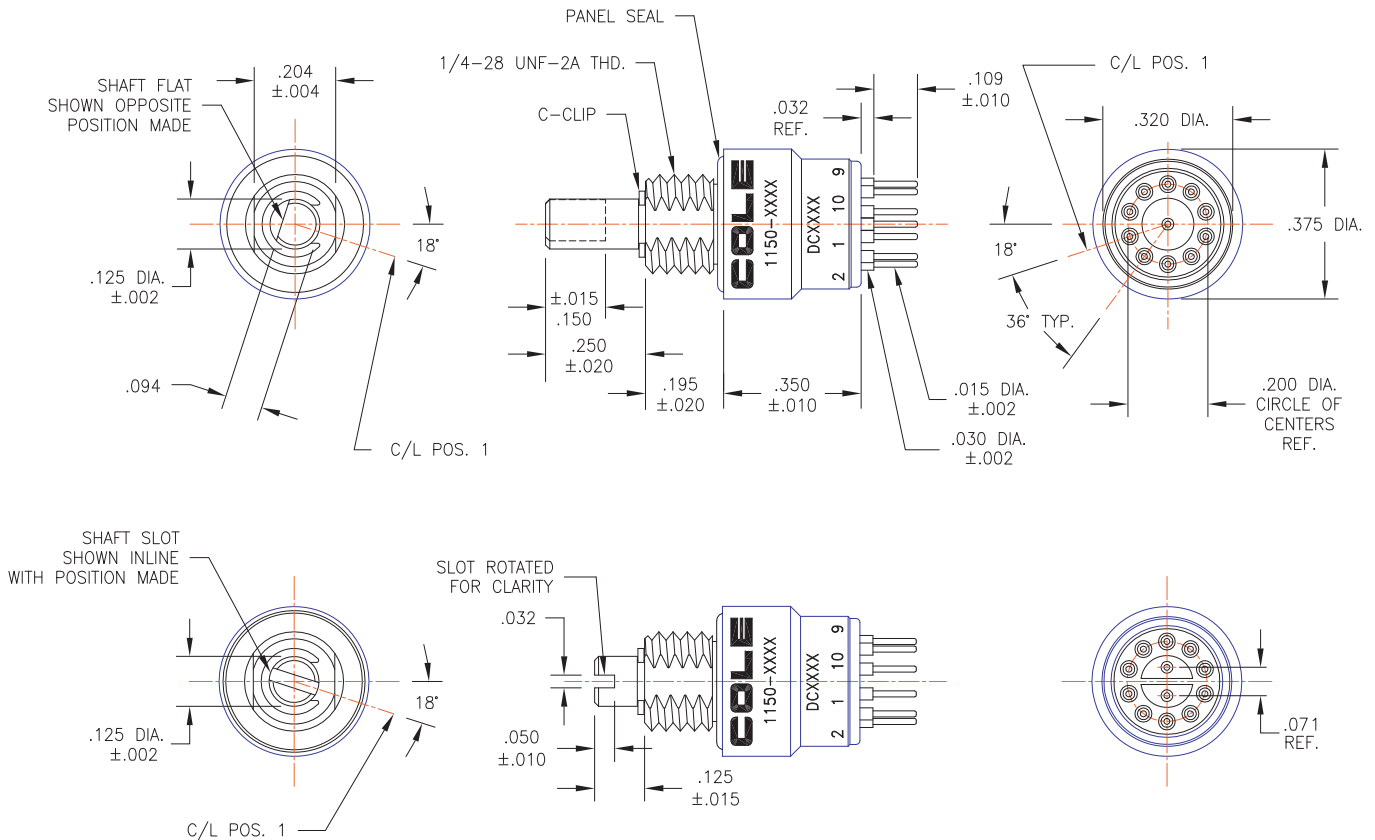

Notes:

1. Dimensions are in inches.
2. Unless otherwise specified, tolerances are $\pm .005$ and $\pm 3^\circ$ on angles (non-accumulative).
4. The screw-driver slotted shaft dimensions are indicated; all other remains the same.
The slot in the shaft lines up with the point of contact of pole number one.
5. Switch is available with non-shorting contact only.
6. See page 6 for circuit diagram and all typical features.

ORDERING INFORMATION

Sample code

B11 36 - 1 04 ****

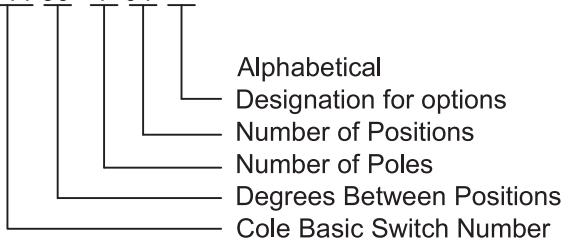

The 1150 series without options if furnished with PC termination, non-shorting and without shaft and panel seals. The standard 10 positions switch is continuous rotation.

OPTIONS

The following options can be added to the standard switch. When ordering, simply add the letter after the basic part number.

F = Fixed stop between the first and last position on the 10 position switch

P = Seal (shaft and panel)

SD = Screwdriver Slot

S = Shorting (not available)



2650 South Croddy Way Phone: 714.556.3100
 P.O. Box 25063 Fax: 714.241.9061
 Santa Ana, CA 92799-5063 Email: sales@cole-switches.com

www.cole-switches.com

ISO9001 CERTIFIED

©2020 Cole Instrument Corp. All rights reserved. C-010318

1150 SERIES

Subminiature Enclosed Precision Rotary Switch

TYPICAL FEATURES

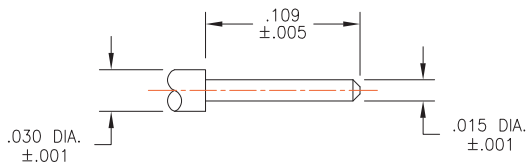
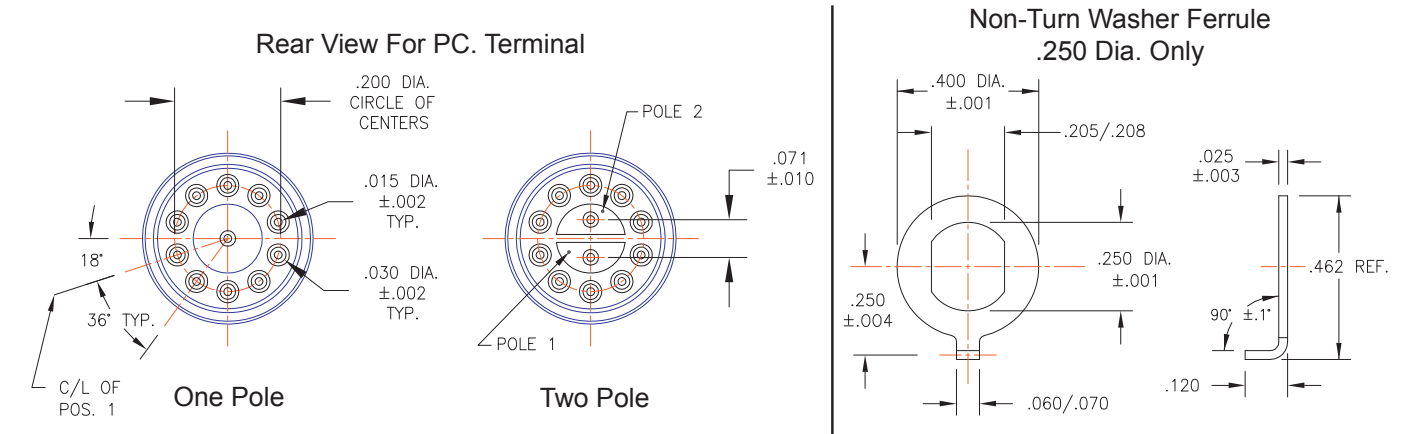

Schematics Diagrams (Viewed From Shaft End and Shown in Position #1) 36° Angle of Throw

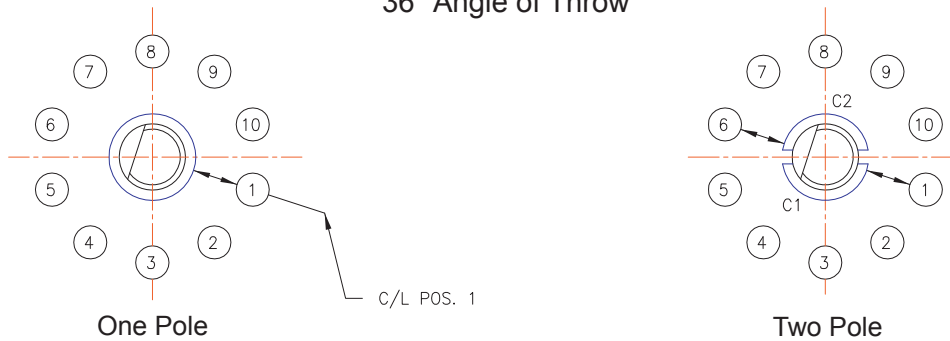

Recommended Panel Cutout .250 Dia. Ferrule

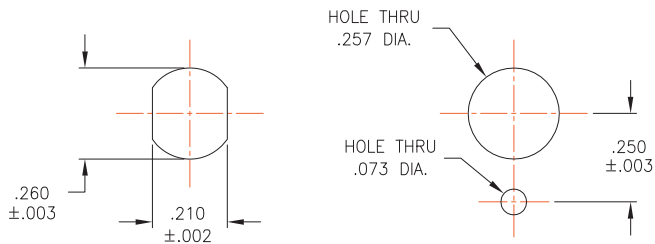

(When Using Non-Turn Washer)

Recommended Panel Cutout 10-32 Ferrule

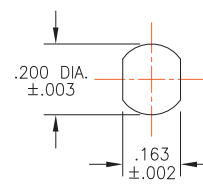

Notes:

1. Dimensions are in inches.
2. Unless otherwise specified, tolerances are ± .010 and ± 3° on angles (non-accumulative).
3. Position 1 and Terminal 1 coincide.
4. Dimension shown are typical for all angles of throw unless otherwise specified.

1150 SERIES

Subminiature Enclosed Precision Rotary Switch

Series 1150 Technical Data

Specification	Unit	Value	Note:
Military Specifications		MIL-DTL-3786	
Continuous (Non-Switching) Current Carrying Capacity	Amps	3	at 28 VDC, with max. contact temperature rise of 20°C
Switching Current Capacity at 28 VDC resistive	Amps	0.200	at Atmospheric pressure with 85°C and at reduced Barometric pressure with 25°C
Switching Current Capacity at 115 VAC resistive	Amps	0.150	
Switching Current Capacity at 28 VDC inductive (2.8 H.)	Amps	0.100	
Switching Current Capacity at 28 VDC Lamp Load	Amps	0.100	
Low Level max. capacity	mA	10	at 30 millivolts DC max.
Dielectric Strength, min.	VRMS	500	
Contact resistance, max. (initial)	milliohms (mΩ)	10	
Contact resistance, max. (after life)	milliohms (mΩ)	50	
Insulation resistance, min. (initial)	megaohms (MΩ)	50,000	at 100 VDC
Insulation resistance, min. (after life)	megaohms (MΩ)	10,000	at 100 VDC
Switching Life	cycles	25,000	at rated loads, sea-level, 25°C, 68% relative humidity
Mechanical Life	cycles	25,000	
Rotational Torque, min.	inch ounces	3	
Rotational Torque, max.	inch ounces	6	
Stop Strength, max.	inch pounds	5	
Mounting Ferrule Strength	inch pounds	12 to 15	
Withstanding Shaft Push Force	pounds	100	
Weight	grams	4	
Molded Parts		thermoplastic	
Contact Surfaces		Gold plated	
Altitude	feet	70,000	typical pressure at 70,000 feet: 0.64 psi
Temperature, min.	degrees Celsius	-65	
Temperature, max.	degrees Celsius	85	
Vibration Tested		Meets	Per MIL-DTL-3786, MIL-STD-202, Method 204, test condition "B", vibration grade 3
Impact Shock, Medium		Meets	MIL-STD 202; Method 213
Impact Shock, High		Meets	at 100g, MIL-STD 202, Method 207
Moisture Resistant		Meets	MIL-STD 202; Method 106
Salt Spray Resistant		Meets	MIL-STD 202, Method 101, Condition "B"
Explosion Proof		Meets	MIL-STD 202, Method 109
Immersion		Meets	3 feet water, MIL-STD-202, method 104, test condition "C"
EMI/RFI		Meets	MIL-DTL-3786, 2 ohms Shaft to ground max.

