



## The Innovative Switch Company

THE OPTION-RICH KL1800  
SERIES KEY LOCK COMBINES  
THE VERSATILITY OF A MULTI-  
FUNCTION SWITCH WITH THE  
HIGH SECURITY OF THE MEDECO  
CYLINDER.

The KLI 800 is available with two types of lock adapters: the KL, the standard high security lock adapter and the MKL, which meets or exceeds the stringent requirements of MIL-DTL-3786.

The KLI 800 is designed for critical and high security applications and demanding usage in aircraft, weapons, medical and industrial control and instrumentation, as well as ground support electronic equipment.

The Medeco lock is designed to resist drilling, wrenching, picking, and other forms of physical attack. In addition, this quality constructed switch is designed with double "D" mounting, versatile master-keying capability, restricted factory-registered key system, and, on request, exclusive key assignment.

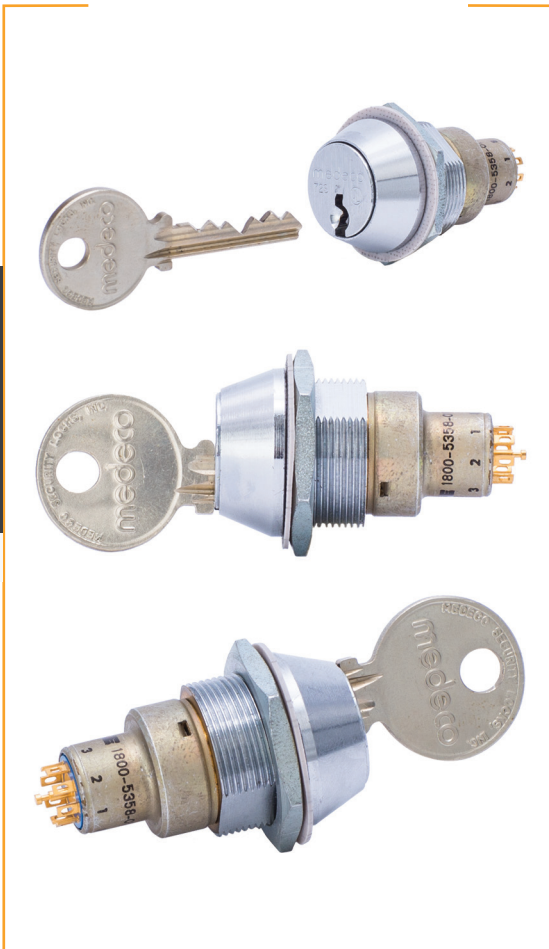

## KL 1800 SERIES Key Lock Half-Inch Enclosed Rotary Switches

# KL 1800 SERIES

## Key Lock Half-Inch Enclosed Rotary Switches

### REMOVAL POSITIONS

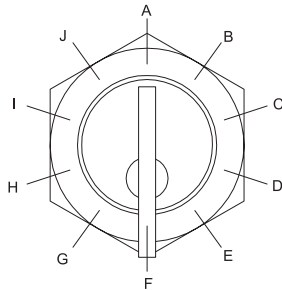

36° INDEXING

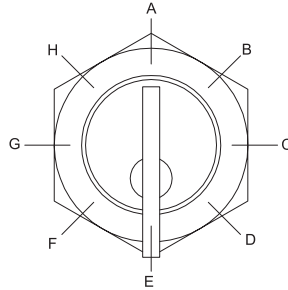

45° INDEXING

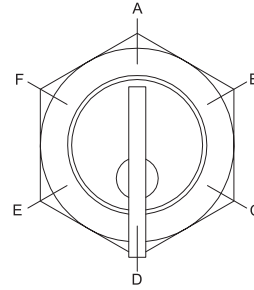

60° INDEXING

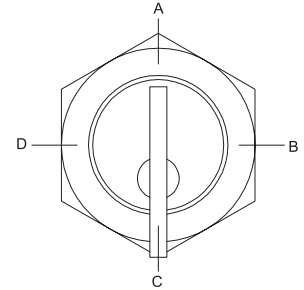

90° INDEXING

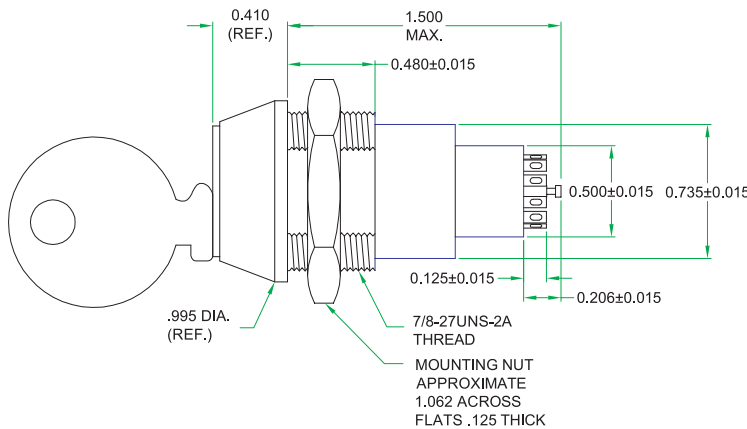

SIDE VIEW

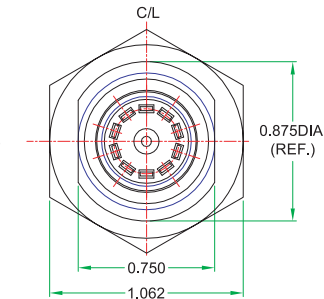

REAR VIEW  
SWITCH SHOWN IN  
POSITION "A"

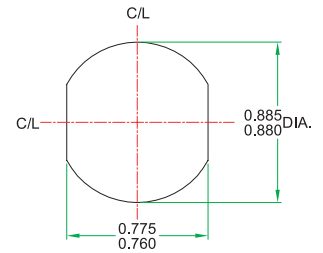

SUGGESTED  
MOUNTING HOLE

#### Option of Location where Key is Removable

Position "A" Thru "J" - 36° Indexing.

Position "A" Thru "H" - 45° Indexing.

Position "A" Thru "F" - 60° Indexing.

Position "A" Thru "D" - 90° Indexing.

The switches are in position #1 when the key in position "A".

#### NOTE

Shown switch 36° indexing - 1 Pole - 10 positions.

# KL 1800 SERIES

## Key Lock Half-Inch Enclosed Rotary Switches

### ORDERING INFORMATION AND NOTES:

#### How to determine part number

KL1836-106S with keypulls at A, B, D and F

Sample part number for a 1800 Series Switch 36°, indexing, 1 pole, 6 positions per pole, shorting switch with key removals at A, B, D and F positions.

1. The chart below lists the standard available combinations for 36°, 45°, 60° and 90° switches.

ANGLE OF THROW (**)	POSITIONS PER POLE	
	ONE POLE	TWO POLES
36°	2 - 10	2 -5
45°	2 - 8	2 -4
60°	2 - 6	2 -3
90°	2 - 4	2

\*\* Shorting and non-shorting contacts are available in 36° angles of throw; non-shorting contacts only are available in 45°, 60° and 90° angles of throw.

2. When ordering specify KL or MKL as a preface to the COLE basic switch number. A special Cole P/N will be assigned.
3. All keylock switches are keyed alike unless otherwise specified.
4. Keylock switches are supplied with full circle of terminals regardless of the number of active positions.
5. 10, 8, 6, 4 positions switches, 36°, 45°, 60° and 90°, angle of throw, respectively, are continuous rotations unless otherwise specified.